

VALET



SMART CENTRE CD PLAYER

User's Manual

iCentral[™]
Intelligent Central Systems
A DIVISION OF **NEAF** CORPORATION

web: www.icentralsystems.com.au
email: sales@icentralsystems.com.au

Sales, Service, Spares consumer enquiries ☎ 1300 050 333

INTRODUCTION

Please read all of the information in this manual before using this unit to insure that you fully understand its capabilities.

WARNING! To prevent fire or electrical shock hazard, do not expose this product to rain or moisture, or remove cover or bottom screws. No user-serviceable parts inside. Refer servicing to qualified personnel.

CONTROLS AND FUNCTIONS

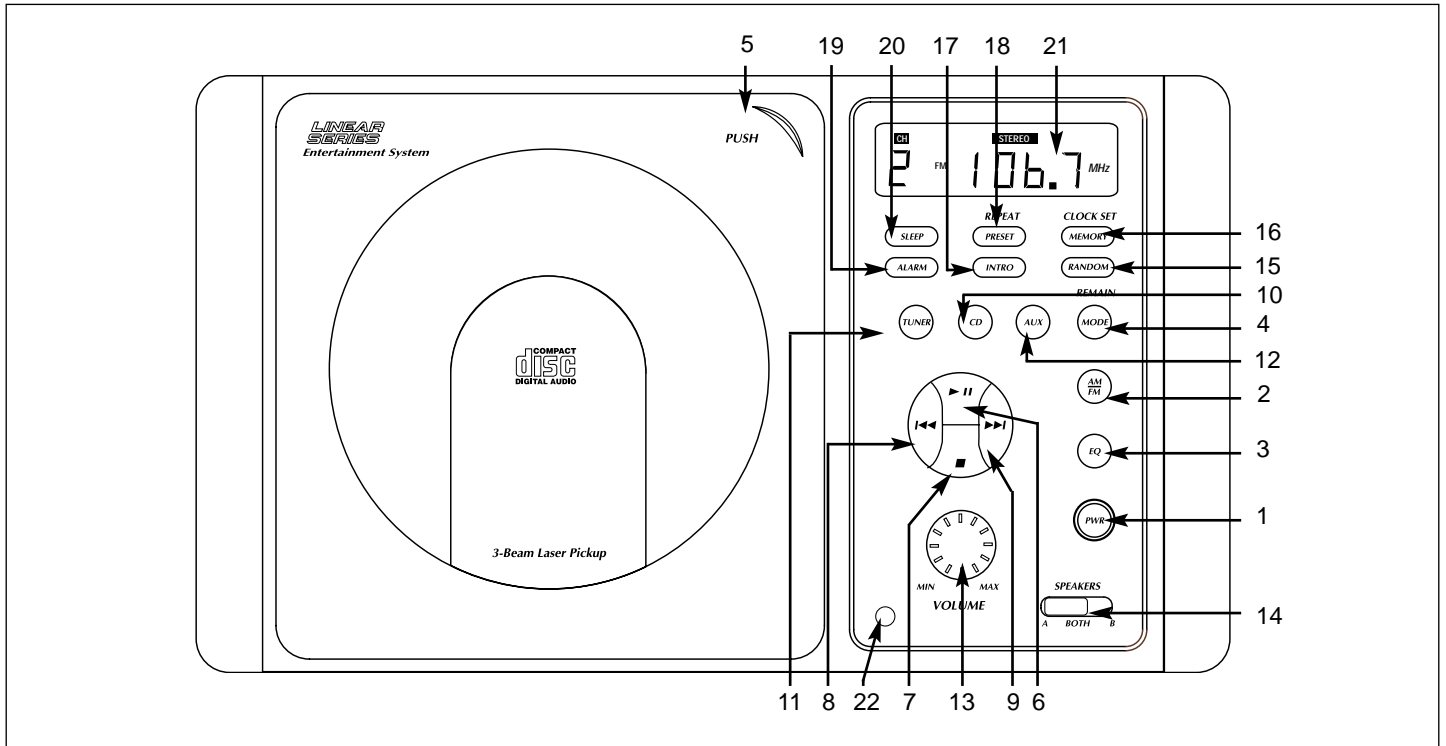

CONTROLS AND FUNCTIONS

1. Power Button (PWR)

Press this button to turn the unit on. Press again to turn the unit off.

2. AM/FM Button

Press this button to select the desired AM or FM radio band.

3. Electronic EQ Selection Button

Preset electronic sound equalization system that allows you to select from 1 of 4 settings to meet your listening taste. The EQ selections are activated in sequence by repeated pressing of the preset "EQ" button. The adjustment sequence is as follows: Classic, Rock, Pop or Normal. Classic, Rock and Pop will be indicated in the Digital LCD Information Center (21).

4. Mode/Remain Button

Press this button to change the Digital LCD Information Center (21). Refer to Radio, CD and Alarm Operation for operating instructions.

5. Compact Disc Door

By pressing the compact disc door next to the word "PUSH", the door will open to allow you to insert a compact disc.

6. Play/Pause Button

After inserting a compact disc, press this button to begin compact disc play. Pressing this button again will pause the compact disc until the button is pressed again.

7. Stop Button

When this button is pressed, compact disc play will stop.

8. Skip Down Button (CD Mode)

To skip to the next lower track on the compact disc, press this button.

Tuning Down Button (Radio Mode)

Pressing this button will take you down the frequency band.

9. Skip Up Button (CD Mode)

To skip to the next higher track on the compact disc, press this button.

Tuning Up Button (Radio Mode)

Pressing this button will take you up the frequency band.

10. CD Button

Press this button to select the CD player.

11. Tuner Button

Press this button to select the radio.

12. Auxiliary Button

Press this button to select input from an auxiliary source.

13. Volume Control Knob

Rotate this knob to increase the volume of the unit.

14. Speaker A/B Selector Buttons

To play the "A" set of speakers, slide the button to the "Speaker A" position. To play the "B" set of speakers, slide the button to the "Speaker B" position. To play the "A" and "B" speakers at the same time, slide the button to the center position.

15. Random CD Button

Press the Random button to play the disc tracks in a random order selected by the disc player.

16. Memory Button (CD Mode)

If you desire to have the song selection of the disc played in a different order than arranged on the disc follow the CD Program Memory procedures.

Memory Button (Radio Mode)

Press this button to memorize the currently displayed radio station. Up to 30 AM or FM radio stations can be memorized. See Radio Operation procedures.

CONTROLS AND FUNCTIONS

17. Intro Button

Press the Intro button to listen to the first 10 seconds of all the tracks on the compact disc. See Compact Disc Operation.

18. Preset/Repeat Button (CD Mode)

Press this button to repeat all tracks of the CD or repeat a single track of the CD. See Compact Disc Operation.

Preset/Repeat Button (Radio Mode)

Press this button to recall memorized radio stations. Radio stations will be recalled in the order they were memorized.

19. Alarm Button

Refer to Alarm Operation.

20. Sleep Button

While the unit is on, press and hold the Sleep button until the desired time is displayed (90, 80, 70, 60, 50, 40, 30, 20, or 10 minutes). After the sleep timer has expired the unit will automatically turn off.

21. Digital LCD Information Center

This display provides digital messages and indicators pertaining to the features being operated such as CD disc selection, EQ settings, and alarm clock settings.

22. Infrared Eye

For use with optional remote control.

RADIO OPERATION

Radio Operation:

1. Press the PWR button (1) in to turn the unit on.
2. Press the TUNER button (11) to select radio operation.
3. Press the AM/FM button (2) to select either the AM or FM radio band.
4. Tune in the desired radio station by pressing Tuning Down button **◀◀** (8) or the Tuning Up button **▶▶** (9).
5. Adjust the VOLUME knob (13) and EQ (3) as desired.

FM Stereo Operation:

The unit will automatically switch from FM mono to FM Stereo when the signal strength increases to a stereo level. If the signal should become weak on stereo reception, the unit will switch back to the mono mode. FM Stereo reception is indicated by the word STEREO in the Digital LCD Information Center.

Memorizing Radio Stations (Presets):

1. Press the PWR button (1) to turn the unit on.
2. Press the TUNER button (11) to select radio operation.
3. Press the AM/FM button (2) to select either the AM or FM radio band.
4. Tune in the desired radio station by pressing Tuning Down button **◀◀** (8) or the Tuning Up button **▶▶** (9).
5. Press the MEMORY button (16).
6. Press the PRESET button (18) and select the desired preset number.

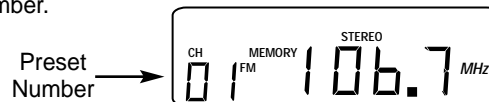

7. Press the MEMORY button (16) once again. The currently displayed radio station is now memorized. Up to 30 AM or FM radio stations can be memorized.

RADIO OPERATION

Recalling Radio Stations (Presets):

Press PRESET button (18) to recall the preset radio stations. The radio stations will be recalled in the order they were memorized.

Graphic Equalizer Operation:

Press the EQ button (3) to activate the preset equalizer levels. Repeated pressing of the EQ button will select: Classic, Rock, Pop or normal in this sequence. Press the button as many times as needed to select the desired EQ setting.

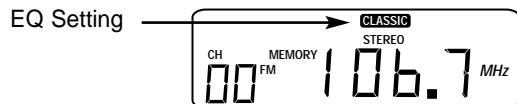

Display Mode Operation:

Pressing the MODE button (4) while displaying the radio frequency will switch the display from radio frequency to time for approximately 5 seconds then return to radio frequency. Continuously pressing the button will display in sequence: Time, Timer On, Timer Off and radio frequency. See "Alarm Operation" for more details.

SETTING THE CLOCK

1. Press the PWR button (1) to turn the unit on.
2. Press the TUNER button (11) to select radio operation.
3. Press the MODE button (4) to display the clock in the LCD digital information area.
4. Within 5 seconds press the MEMORY/CLOCK SET button (16) the "hour" will start flashing.
5. Press either the Skip Down button **I◀◀** (8) or Skip Up button **▶▶I** (9) to select the desired hour. When selecting hour note the AM or PM indicator in the Digital Information Center.

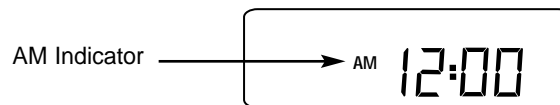

6. Press the MEMORY/CLOCK SET button (16) again and the "minutes" will start flashing.
7. Press either the Skip Down button **I◀◀** (8) or Skip Up button **▶▶I** (9) to select the desired minutes.
8. Press the MEMORY/CLOCK SET button (16) one more time to exit clock setting mode.

SETTING THE SLEEP TIMER

1. Press the PWR button (1) to turn the unit on.
2. Press and hold the SLEEP button (20) until the desired sleep time is displayed (90, 80, 70, 60, 50, 40, 30, 20, 10 minutes).

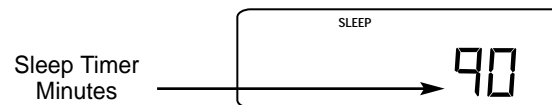

3. After the sleep timer has expired the unit will automatically turn off.
Note: You must reset the sleep timer every time you turn the unit on.

COMPACT DISC OPERATION

Compact Disc Operation:

1. Press the PWR button (1) in to turn the unit on.
2. Press the CD button (10) to select CD operation.
3. Press the door (5) and gently pull the compact disc door open fully.
4. Insert a disc onto the disc hub and press gently in the center until the disc is secure and supported by the hub.
5. Close the compact disc door until it snaps into place.
6. Press the Skip Down button **I◀◀** (8) or Skip Up button **▶▶I** (9) to select a specific track.
7. Press the Play button **▶||** (6) then adjust the volume and EQ controls as desired.
8. Press the Stop button **■** (7) to stop the CD from playing.

Warning ! Never touch the laser eye. Moisture and oils from your fingers can impair proper operation.

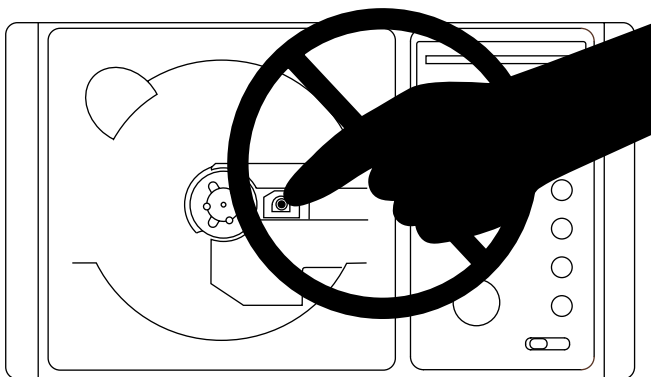

CD Program Memory:

If you desire to have the song selection of the disc played in a different order than arranged on the disc, repeat the following procedures to program the playing order.

1. Press the MEMORY button (16). "TRACK MEMORY" will flash in the informational display (21).



2. Within 5 seconds press the Skip Down button **I◀◀** (8) or Skip Up button **▶▶I** (9) to select the first CD track to memorize. Press the MEMORY button (16) to lock in the selection.
3. Repeat Step #2 as many times as needed to program the listening order of the tracks on the disk. Up to 20 tracks can be memorized.



4. After all the desired songs are programmed, press the MEMORY button (16) once again to lock the program. The LCD information Center will then display the play order you programmed.
5. Press the Play button **▶||** (6) to play the new program.

Note 1: Pressing the Stop button (7) will stop the play function but will not erase the program sequence. Press the MEMORY (16) button, then the Play button (6) once again this will start the play/program function from the first programmed track.

Note 2: Opening the CD door, changing the source selection to FM or AM, and shutting the power off will clear the program memory.

COMPACT DISC OPERATION

Using the Random Feature:

The random feature allows the disk player to select and play the songs on the disk in random order.

1. To initiate the random feature, insert a disk and close the CD door. Press the RANDOM button (15), before pressing the Play button. The function is active when the "RANDOM" indicator is displayed in the informational display (21) area. Press Play ► (6) and the disk will play in random order.



2. To turn off the random function, press the RANDOM button (15) again. The "RANDOM" indicator in the informational display (21) will be off.

Note: You can activate and deactivate the random feature at any time by pressing the Random button.

Using the Repeat Feature:

The repeat feature has two modes of operation. The entire disc can be continuously repeated, or a single track can be continuously repeated.

Repeating Entire CD:

Press the REPEAT button (18) one time while a CD is playing. "REPEAT" will appear in the digital information display (21) area. The CD will repeat all tracks of the CD continuously.



Repeating Single CD Track:

Press the REPEAT button (18) twice while a CD is playing. "REPEAT" will appear flashing in the digital information display (21) area. The song that is playing will repeat itself continuously.



Canceling Repeat Feature:

Press the REPEAT button (18) until "REPEAT" is no longer displayed in the digital information display (21) area.

COMPACT DISC OPERATION

Using the Intro Feature:

The intro feature allows the disc player to play the beginning of each track for 10 seconds, and then move on to the next track. This allows the user to preview each song quickly, or to find a selection where the title may be unknown but the melody is familiar.

1. Press the INTRO button (17) "INTRO" will appear in the display. The first song will automatically start playing.

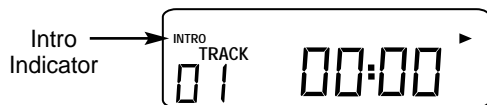

2. When you find the song you want to listen to, press the INTRO button (17) again to turn off this feature.

Handling the Disc:

1. When inserting the disc, hold the disc with your thumb, middle finger and index finger, and press the center with your index finger.
2. When removing the disc, always pull at the left or right edge of the disc until it snaps loose from the disc hub. There are indentations in the plastic for your fingers at these points.
3. Always keep your discs clean and free from scratches, fingerprints and dirt.

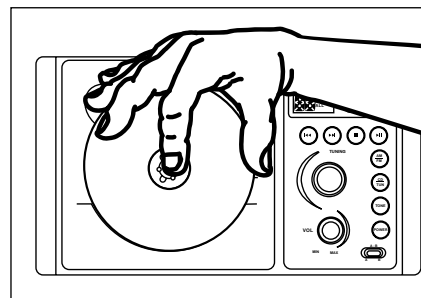

ALARM OPERATION

Using the Alarm Feature:

This function is used when the unit is powered off, then it powers on at a set time, and then powers off at another set time. The alarm on and off times are set by the user. The alarm can be set when the unit is either on or off.

Setting the Alarm On Timer

1. Press the MODE/REMAIN button (4) twice to display the "TIMER ON" clock in the LCD digital information area.

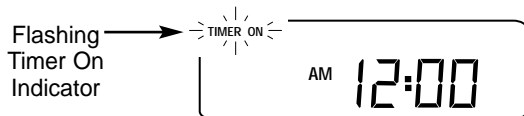

2. Within 5 seconds press the MEMORY/CLOCK SET (16) button the "hour" will start flashing.
3. Press either the Skip Down button **◀◀** (8) or Skip Up button **▶▶** (9) to select the desired hour. When selecting hour note the AM or PM indicator in the Digital Information Center.

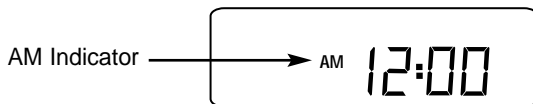

4. Press the MEMORY/CLOCK SET (16) button again and the "minutes" will start flashing.
5. Press either the Skip Down button **◀◀** (8) or Skip Up button **▶▶** (9) to select the desired minutes.
6. Press the MODE (4) button again to enter "Setting the Alarm Off Timer" or wait 5 seconds and the unit will exit alarm programming.

Setting the Alarm Off Timer

1. Press the MODE/REMAIN button (4) to display the "TIMER OFF" clock in the LCD digital information area.

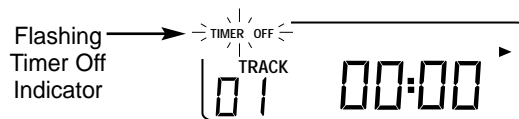

2. Within 5 seconds press the MEMORY/CLOCK SET (16) button the "hour" will start flashing.
3. Press either the Skip Down button **◀◀** (8) or Skip Up button **▶▶** (9) to select the desired hour. When selecting hour note the AM or PM indicator in the Digital Information Center.

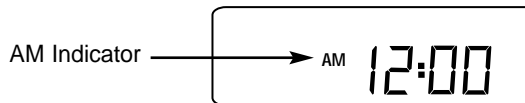

4. Press the MEMORY/CLOCK SET (16) button again and the "minutes" will start flashing.
5. Press either the Skip Down button **◀◀** (8) or Skip Up button **▶▶** (9) to select the desired minutes.
6. Press the MODE (4) button again or wait 5 seconds and the unit will exit alarm programming.

Activating the Alarm

1. Press the ALARM button (19) to activate the programmed Power On and Power Off times. TIMER will be displayed in the Digital Information Center.

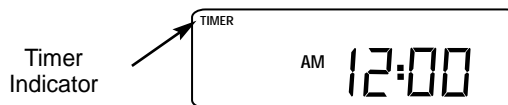

INSTALLATION

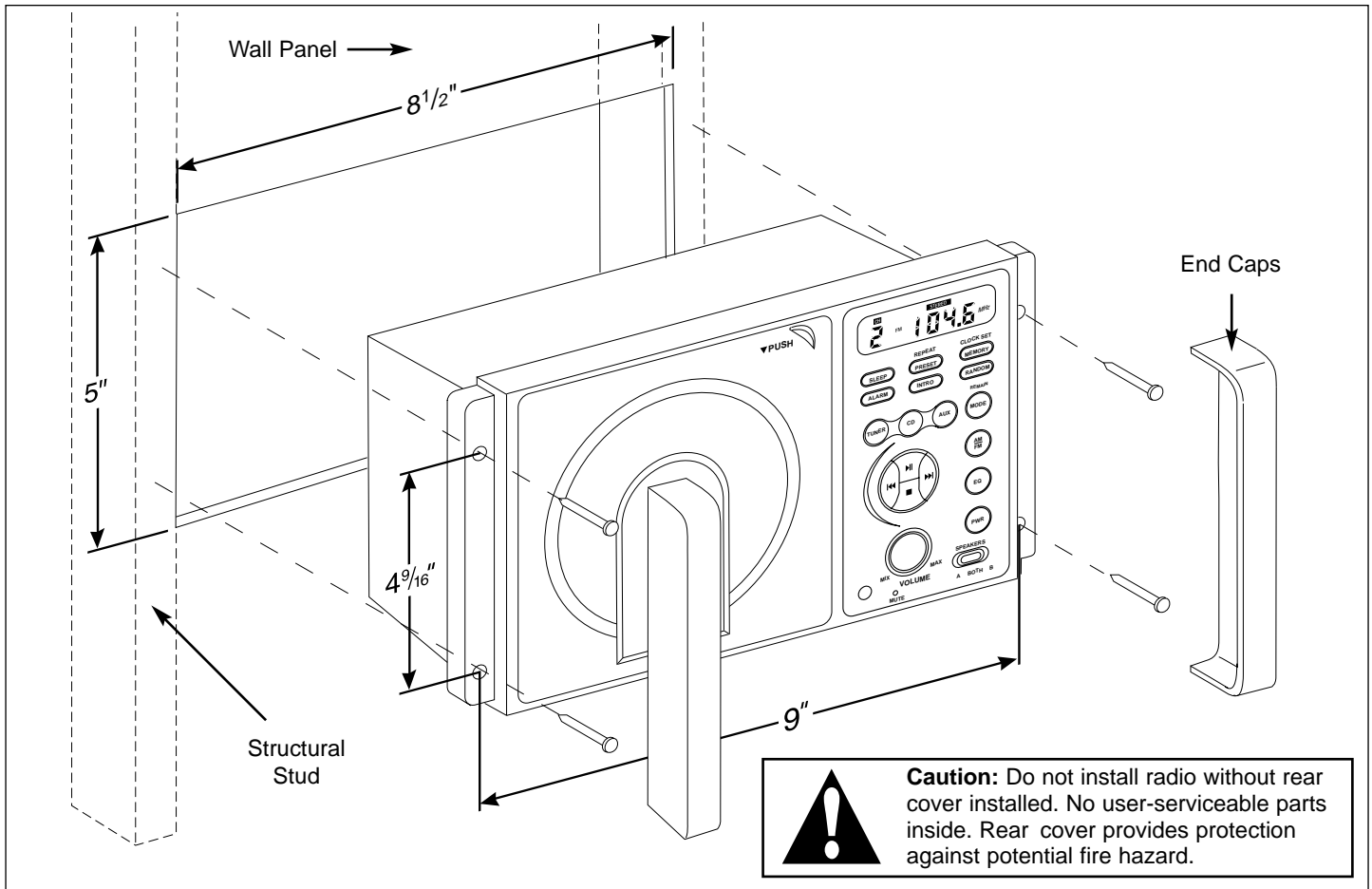

POWER CONNECTIONS

This unit for use only with a 12 volt DC power source with a negative ground.

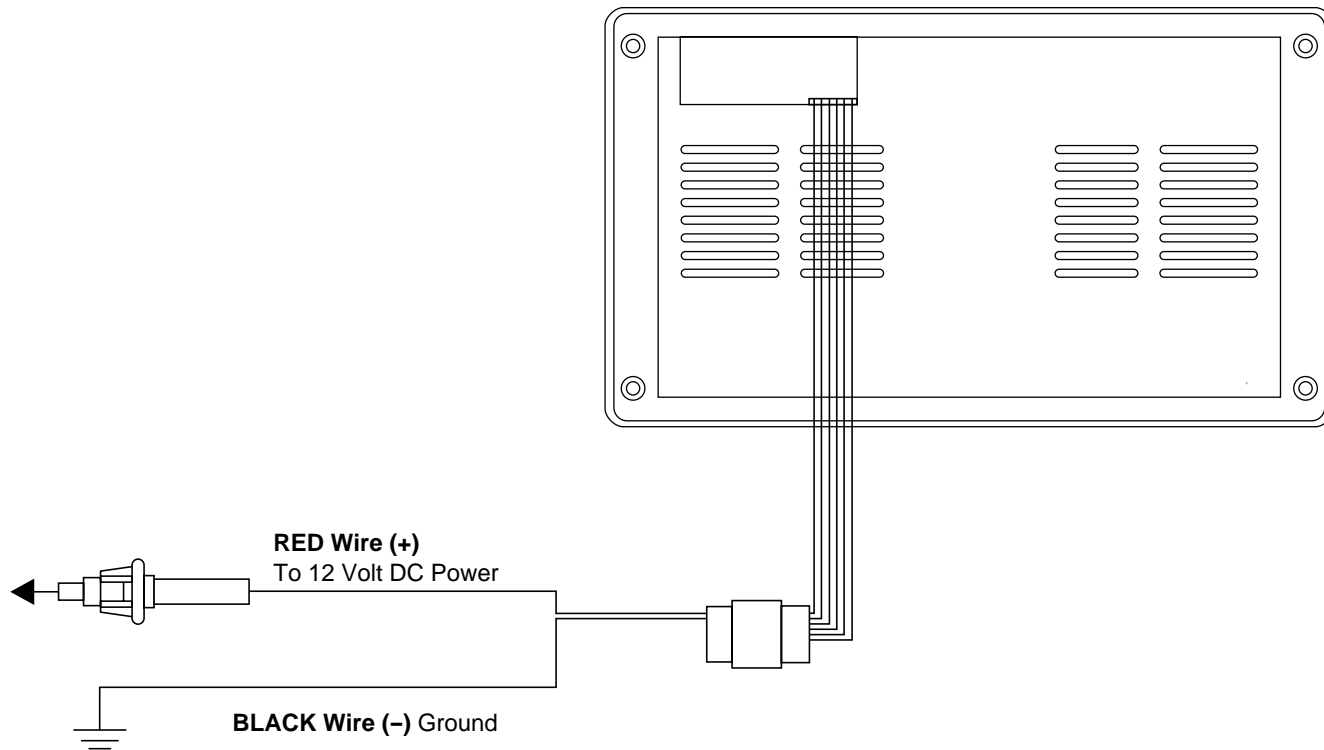

SPEAKER CONNECTIONS

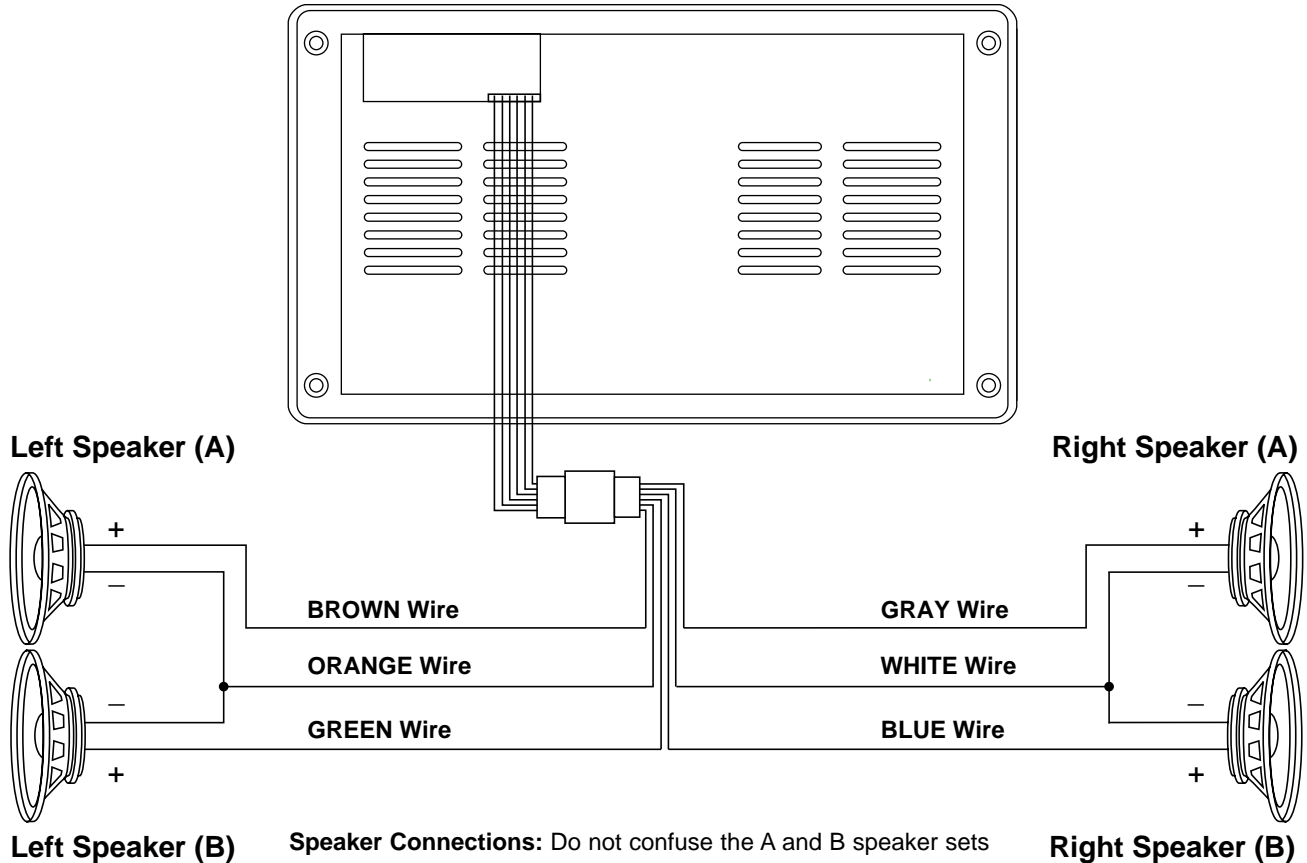

ANTENNA CONNECTIONS

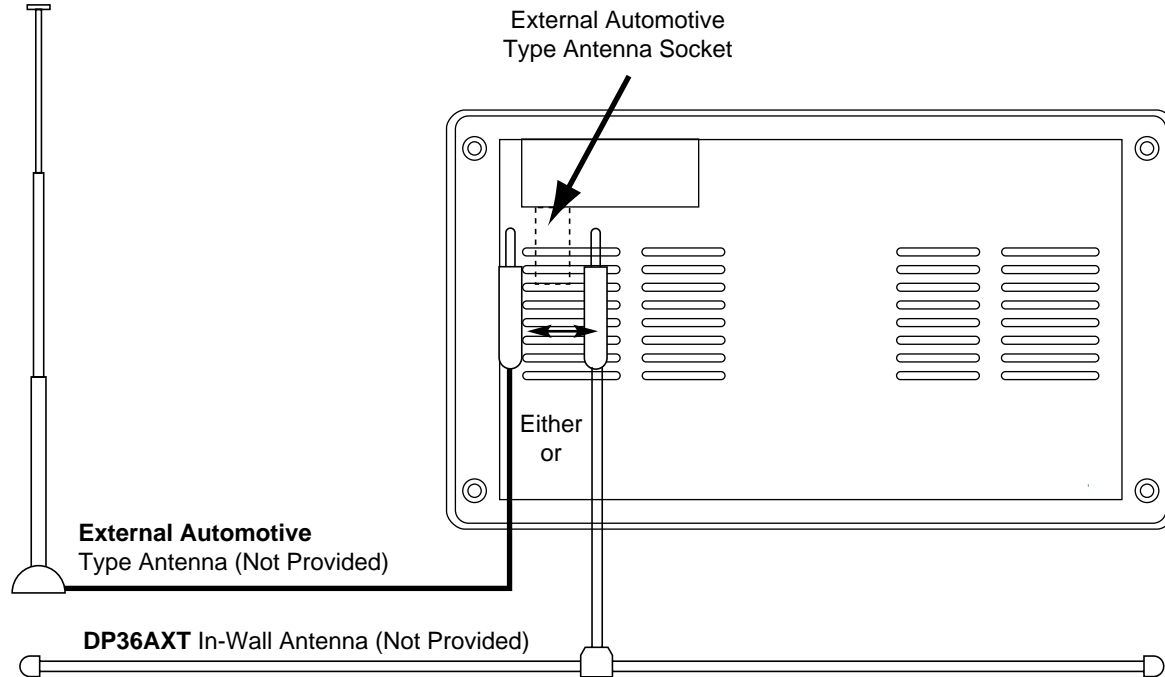

The LS4500, LS4501 have a provision for a standard automotive antenna. If an automotive antenna is used, insert the male plug from the antenna into the female receptacle provided on the unit.

If an automotive antenna is not available or is undesired, we recommend the use of a Magnadyne DP36AXT di-pole antenna substitute. Insert the male plug from the DP36AXT into the female receptacle of the LS4500, LS4501 unit and allow the cable of the antenna to lay inside the wall.

AUXILIARY CONNECTIONS

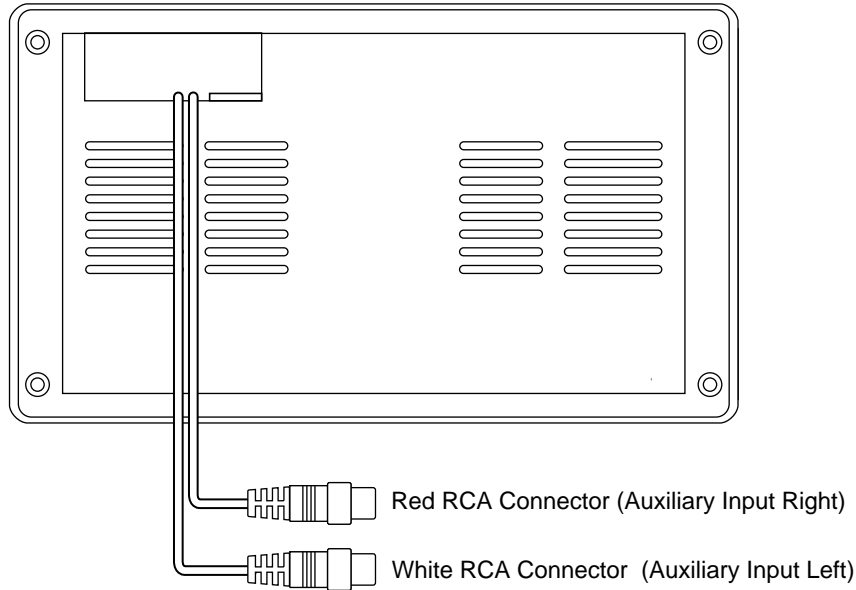

Aux Audio Input: Left and Right RCA type input jacks are provided on the back panel for connection to a second sound source such as a TV system or component cassette deck. Connect a stereo "male to male" patch cord to the units input jacks and then connect the remaining ends to the second sound sources output jacks.

Note: If the second sound source only has a single mono output jack, it may be necessary to use a "Y" adapter to provide both the left and right inputs.

SAFETY INSTRUCTIONS

Read Instructions: All the safety and operating instructions should be read before the appliance is operated.

Retain Instructions: The safety and operating instructions should be retained for future reference.

Heed Warnings: All warnings on the appliance and in the operating instructions should be adhered to.

Follow Instructions: All operating and use instructions should be followed.

Water and Moisture: The appliance should not be used near water. For example, near a bathtub, washbowl, kitchen sink, laundry tub, in a wet basement, or near a swimming pool, etc.

Wall or Ceiling Mounting: The appliance should be mounted to a wall or ceiling only recommended by the manufacturer.

Heat: The appliance should be situated away from heat sources such as radiators, heat registers, stoves, or other appliances (including amplifiers) that produce heat.

Power Supply: The appliance should be connected to a power supply only of the type described in the operating instructions or as marked on the appliance.

Cleaning: The appliance should be cleaned only as recommended by the manufacturer.

Power Lines: An outdoor antenna should be located away from power lines.

Outdoor Antenna Grounding: If an outside antenna is connected to the receiver, be sure the antenna system is grounded, so as to provide some protection against voltage surges and built up static charges. Section 810 of the National Electrical Code, ANSI/NFPA No. 70-1983, provides information with respect to proper grounding of the mast and supporting structure, grounding of the lead-in wire to an antenna discharge unit, size of grounding conductors, location of antenna-discharge unit, connection to grounding electrodes, and requirements for the grounding electrode. See Figure 1.

Object and Liquid Entry: Care should be taken so that objects do not fall, and liquids are not spilled into the enclosure through openings.

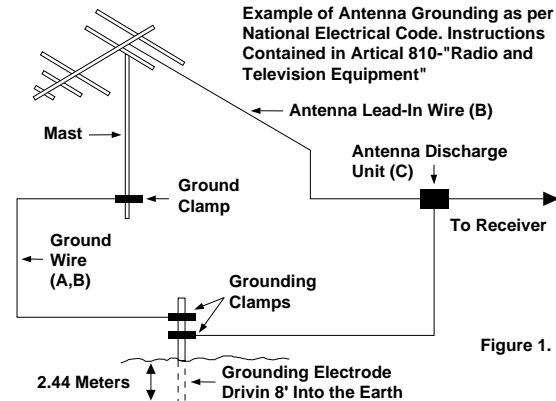

- A) Use No. 10 AWG (5.3mm²) copper, No. 8 AWG (8.4mm²) aluminum, No. 17 AWG (1.0mm²) copper clad steel or bronze wire, or larger as ground wire.
- B) Secure antenna lead-in and ground wires to house with stand-off insulators spaced from 4 feet (1.22m) to 6 feet (1.83m) apart.
- C) Mount antenna discharge unit as close as possible to where lead-in enters house.

OPERATION AND MAINTENANCE

Damage Requiring Service: The appliance should be serviced by qualified personnel when:

- A. The power supply cord or the plug has been damaged; or
- B. Objects have fallen, or liquid has spilled into the appliance; or
- C. The appliance has been exposed to rain; or
- D. The appliance does not appear to operate normally or exhibits a marked change in performance; or
- E. The appliance has been dropped, or the enclosure damaged.

Servicing: The user should not attempt to service the appliance beyond that described in the operating instructions. All other servicing should be referred to qualified personnel.

Caution:

Compact disc should be stored in a container or vinyl bag to prevent contamination. Disc should not be placed in locations exposed to sunlight or heat.

Warnings



Handle CD's Properly

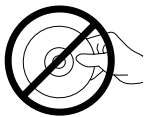

Do Not Touch CD's



Do Not Get Dirt on CD's

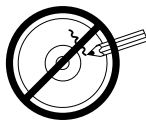

Do Not Write on CD's



Do Not Scratch CD's

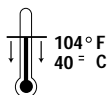

Keep Below 104° F
40° C

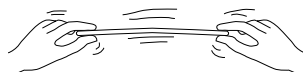

Do Not Bend CD's

WARRANTY

ONE (1) YEAR LIMITED WARRANTY

Magnadyne Corporation or its authorized agents will within 1 year from the date of sale to you, repair, replace or refund the retail sales price of said product or any part thereof, at the option of the Magnadyne Corporation or its authorized agents, if said product or part is found defective in materials or workmanship, when properly connected and operating on the correct power requirements designated for the specific product. This warranty and Magnadyne Corporation or its authorized agents obligations hereunder do not apply where the product was; damaged while in the possession of the consumer, subjected to unreasonable or unintended use, not reasonably maintained, utilized in commercial or industrial operations, or serviced by anyone other than Magnadyne Corporation or its authorized agents, or where the warning seal on the product is broken or the power and/or plugs are detached from the unit. Magnadyne Corporation or any of its authorized agents will not assume any labor costs for the removal and re-installation of any product found to be defective, or the cost of transportation to Magnadyne Corporation or its authorized agents. Such costs are the sole responsibility of the purchaser.

This warranty does not cover the cabinet appearance items or accessories used in connection with this product, or any damaged to recording or recording tape, or any damage to the to the products resulting from improper installation, alteration, accident, misuse, abuse or acts of nature.

MAGNADYNE CORPORATION OR ITS AUTHORIZED AGENTS SHALL NOT BE LIABLE TO ANYONE FOR CONSEQUENTIAL OR INCIDENTAL DAMAGES OR CLAIMS EXCEPT THOSE ACCORDED BY LAW. NO EXPRESSED WARRANTY OR IMPLIED WARRANTY IS GIVEN EXCEPT THOSE SET FORTH HEREIN. NO IMPLIED WARRANTY SHALL EXTEND BEYOND 1 YEAR FROM THE DATE OF SALE.

This warranty extends only to the original purchaser of the product and is not transferable.

Some states do not allow limitations on how long an implied warranty lasts, and some states do not allow the exclusion or limitation of incidental or consequential damages, so the above limitations or exclusion may not apply to you. This warranty gives you specific legal rights, and you may have other rights that vary from state to state.

Defective merchandise should be returned to the original point of purchase or secondly, to Magnadyne Corporation, 1111 W. Victoria Street, Compton CA 90220. A Return Authorization must be obtained before sending any product or merchandise may be refused.